

Dolce II Basin/Bath Mixer

Nero

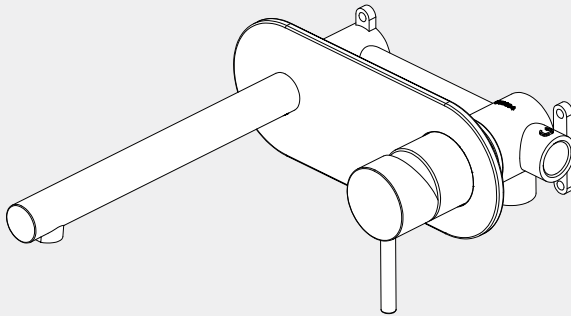

Lead Free



Version : 202506



Drawing

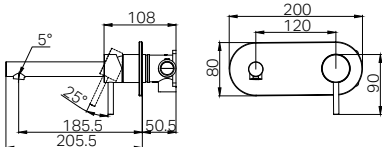





Specifications

Watermark License
WM-060073
Temperature Rating
Min 1 °C - Max 75 °C
Pressure Rating
Min 150kpa - Max 500kpa

Group Items

1 x Universal Body
1 x Trim Kits
1 x Extra Aerator(Without
Flow Restrictor)

Finish & SKU

- | | | |
|---|---|--|
|  Chrome
25B005CH |  Matte Black
25B005MB |  Gun Metal
25B005GM |
|  Brushed Gold
25B005BG |  Brushed Nickel
25B005BN | |

*Dimensions are nominal measurements only.

INSTALLATION INSTRUCTIONS

GENERAL INSTRUCTIONS:

- This product must be installed by a licensed plumber. Ensure that your plumbing installation conforms to the Australian/New Zealand Standard AS/NZS 3500.
- All pipework must be thoroughly flushed prior to the installation of the mixer. In-line filters must be fitted on both hot and cold supplies to prevent foreign particles from damaging the ceramic cartridge.
- All outlets used primarily for personal hygiene must deliver water at a safe temperature in accordance with regional regulations.

INSTALLATION STEPS FOR BODY

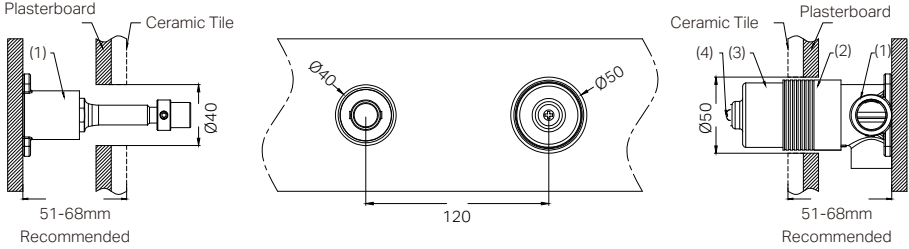

1. Secure the mixer body (1) to the nogging, ensuring an installation depth of 51-68mm from the nogging to the ceramic tile.

Note: Do not remove the protective sleeve (2) from the mixer body.

2. Connect the cold and hot water supply lines and perform a leak test.

3. Drill a $\varnothing 50\text{mm}$ and a $\varnothing 40\text{mm}$ hole in the plasterboard for mixer body installation, and then position the plasterboard as shown in the above diagram.

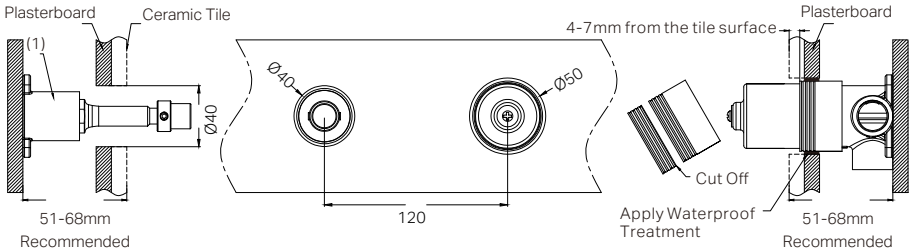

4. Measure 4–7 mm inward from the tile's outer surface and mark the corresponding position on the protective sleeve. Then, waterproof the gap between the plasterboard and body.

5. Remove the self-tapping screw, washer, and protective sleeve, then cut the sleeve at the marked point.

6. Reattach the self-tapping screw, washer, and protective sleeve.

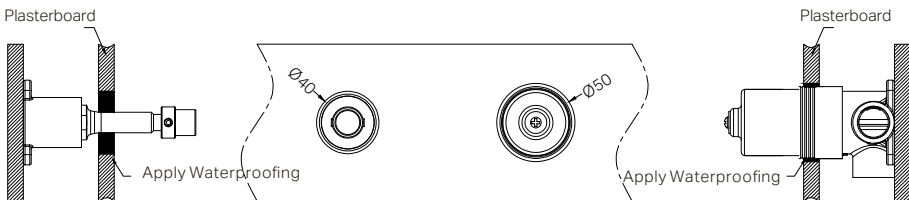

7. Waterproof the gap between the plasterboard and body.

INSTALLATION STEPS FOR TRIM KITS

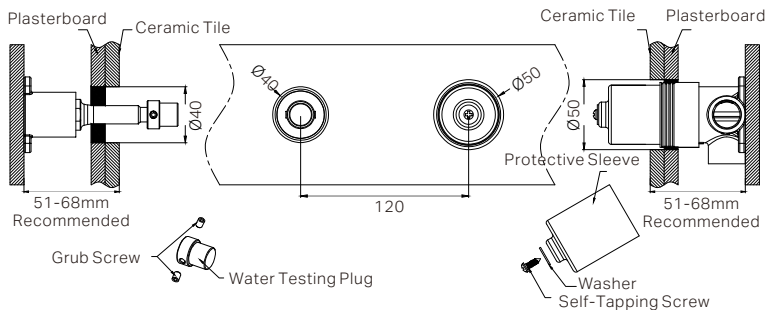

1. Drill a $\varnothing 50\text{mm}$ and a $\varnothing 40\text{mm}$ hole in the ceramic tile, then position it as shown in the above diagram.
2. Undo the self-taping screw to remove the protective sleeve, and release the grub screws to remove the water testing plug.

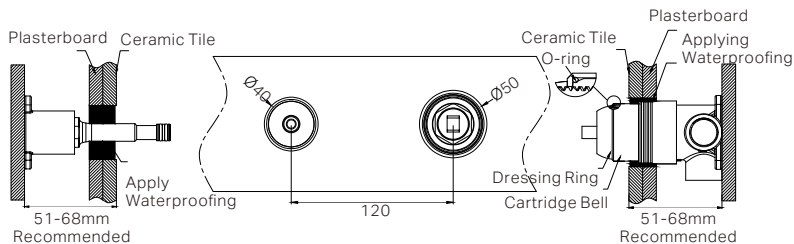

3. Slide the cartridge bell onto the body and insert the O-ring to the groove of the cartridge bell.
4. Apply waterproof treatment to the area in the diagram above.
5. Tighten the dressing ring onto the cartridge bell.

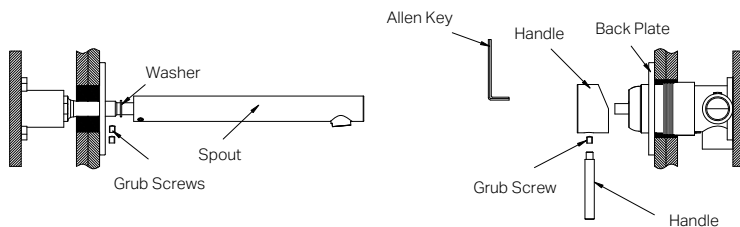

6. Slide the back plate and washer onto the wall, set the spout in place, and secure it tightly using the grub screw.
7. Insert the handle onto the cartridge stem, unscrew the handle rod, and use a allen key to tighten the grub screw to secure the handle. Then, screw the handle rod back in place.

REPLACING THE AERATOR

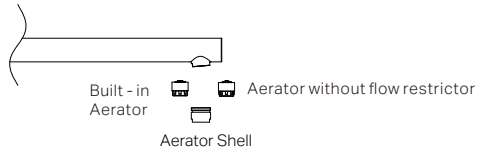

Note:

The built-in aerator is equipped with an internal flow restrictor, while the extra aerator included in the box does not have one. You can switch them based on your needs.

Nero



Warranty Policy