

MECCA CARE MAKE YOUR OWN GRAB RAILS SERIES

Nero

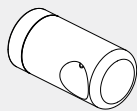

End Bracket 32mm

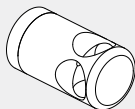

90 Degree Bracket 32mm

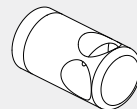

T-Bar Bracket 32mm

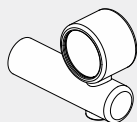

Undermount Mid Bracket 32mm

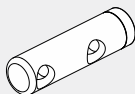

Double Towel Bracket 25mm
(Left)

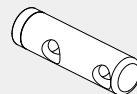

Double Towel Bracket 25mm
(Right)

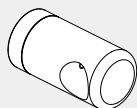

End Bracket 25mm

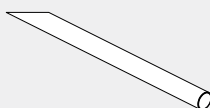

Grab Rail 32mm x 1200mm

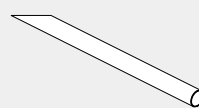

Grab Rail 25mm x 1200mm

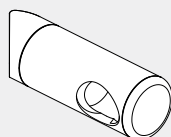

Corner Wrap Bracket 32mm

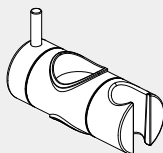

Slider for 32mm Grab Rail

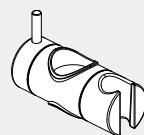







Slider for 25mm Grab Rail

Version : 202507

Features

- Rails can be cut to any size during installation to suit wall supports
- 150kg capacity on all 32mm and 25mm diameter grab rails
- 25mm Diameter rails suitable for private homes and assisted living
- 32mm Diameter rails compliant for AS1428.1 Bathrooms as grab rails
- Mid brackets allow for rails to join and continue
- Brackets and rails can be added to existing Mecca Care Grab Rail sets to create new combinations

Color Options

-  Chrome
-  Gun Metal
-  Brushed Nickel
-  Matte Black
-  Brushed Gold
-  Brushed Bronze

32MM SERIES

END BRACKET 32MM

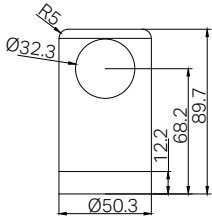

CORNER WRAP BRACKET 32MM

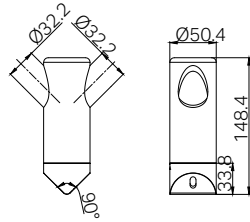

90 DEGREE BRACKET 32MM

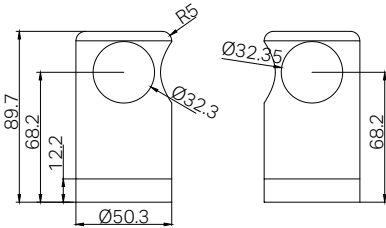

SLIDER FOR 32MM GRAB RAIL

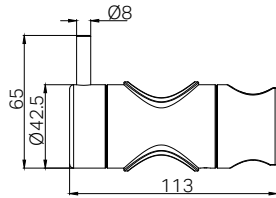

T-BAR BRACKET 32MM

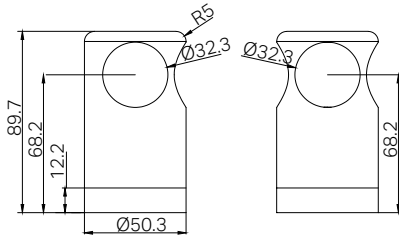

UNDERMOUNT MID BRACKET 32MM

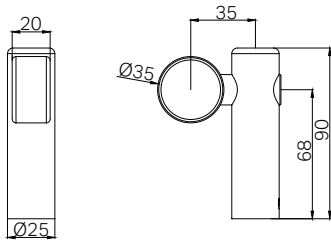

GRAB RAIL 32MM X 1200MM

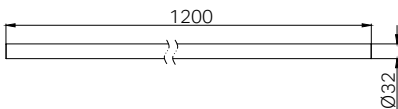

25MM SERIES

END BRACKET 25MM

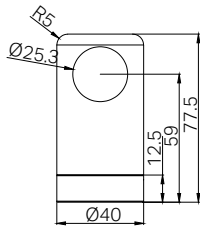

SLIDER FOR 25MM GRAB RAIL

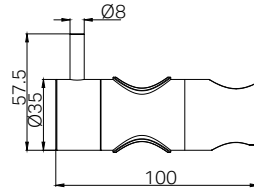

DOUBLE TOWEL BRACKET 25MM (LEFT)

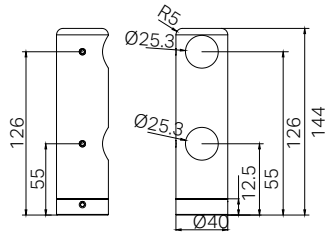

DOUBLE TOWEL BRACKET 25MM (RIGHT)

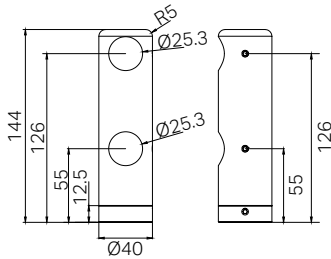

GRAB RAIL 25MM X 1200MM

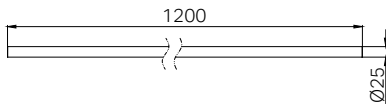

INSTALLATION INSTRUCTIONS

GENERAL INSTRUCTIONS

- The Mecca Care Make Your Own Grab Rail Series is designed to allow users to customize and combine components freely, in order to better meet their individual and diverse needs.
- Can be used with existing Mecca Care Grab Rails or as part of a new custom configuration.
- Rails can be resized and installed to comply with AS1428.1 if required, test reports are available on request
- 150kg load capacity when used with compatible components and installed to specification.
- All installations must be performed by a licensed trade professional, and configurations may require approval from an Occupational Therapist (OT).
- All brackets must be installed into wall supports like wall studs, noggins, brick or concrete to ensure the rails can withstand the load capacity.
- Check wall structure and reinforce if needed.
- Correct installation is required to ensure safe, long term operation.
- Incorrect mounting can result in reduced capacity of the rail which can result in injury to user and damage to the wall.

MAINTENANCE AND CARE

- To ensure ongoing safety and optimal performance, Mecca Care products should be regularly maintained.
- Periodically check all grab rails, brackets, and fixings for signs of wear, looseness, corrosion, or damage.
- Re-tighten all visible screws or fixings as needed to maintain structural stability.
- Do not use abrasive pads, strong acids, bleach, or harsh chemical cleaners, as they may damage the surface or reduce grip strength.

PARTS NAME

Note: If the product you selected is not included in the diagram below, please refer to a similar product to view its exploded view.

END BRACKET 32MM

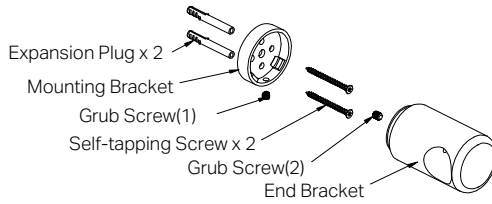

UNDERMOUNT MID BRACKET 32MM

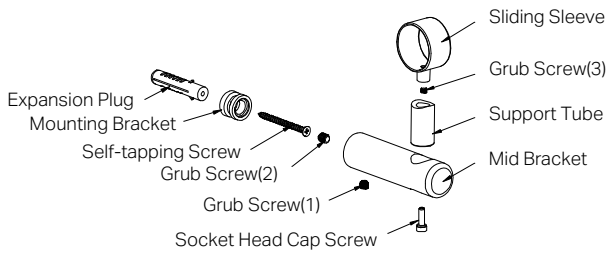

CORNER WRAP BRACKET 32MM

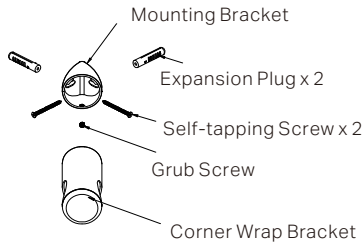

DOUBLE TOWEL BRACKET 32MM

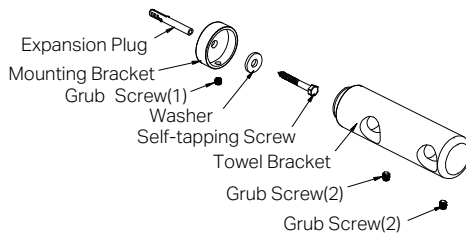

PARTS NAME

90 DEGREE BRACKET 32MM

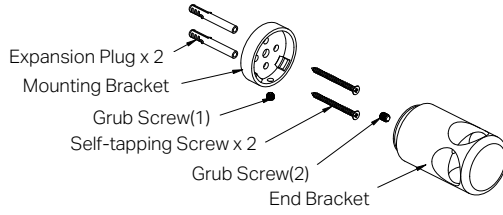

T-BAR BRACKET 32MM

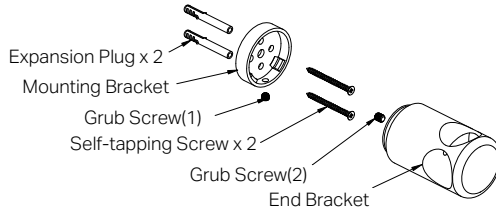

INSTALLATION STEPS FOR 32MM SERIES

FOR 32MM END BRACKET, 90 DEGREE BRACKET, T-BAR BRACKET AND CORNER WRAP BRACKET.

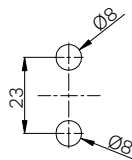
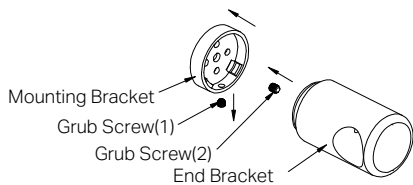

01. Unscrew the grub screw(1) and remove the mounting bracket. Then loosen or remove the grub screw(2) from the end bracket.

02. Drill two 8mm diameter mounting holes in the wall where the end bracket is to be installed.

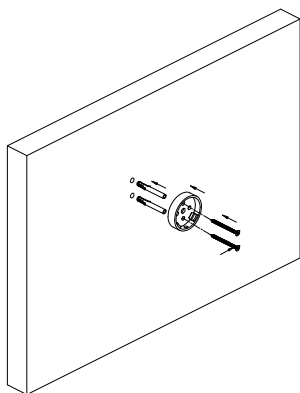

03. Fix the mounting bracket to the wall using the expansion plugs and the self-tapping screws.

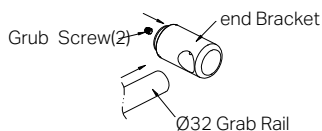

04. Insert the grab rail fully into the end bracket, then tighten the grub screw(2) to secure the grab rail in place.

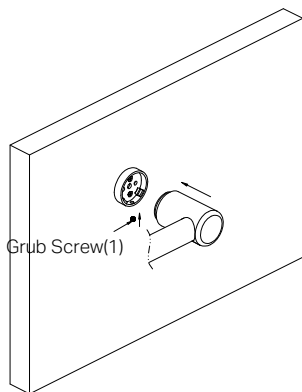

05. Insert the end bracket into the mounting bracket, then tighten the grub screw(1) to secure it.

INSTALLATION STEPS FOR 32MM SERIES FOR UNDERMOUNT MID BRACKET.

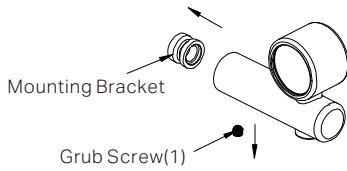

01. Unscrew the grub screw(1) and remove the mounting bracket from the mid bracket.



02. Mark and drill a Ø8mm hole at the desired bracket location.

Note: Ensure the grab rail will sit horizontally once installed.

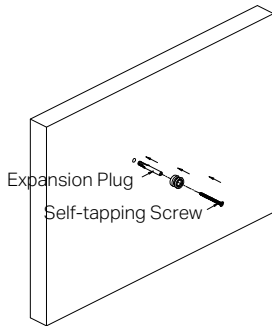

03. Secure the mounting bracket to the wall using supplied expansion plug and the self-tapping screw.

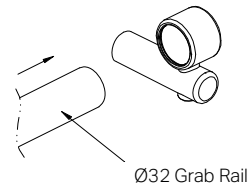

04. Slide the 32mm grab rail through bracket sleeve.

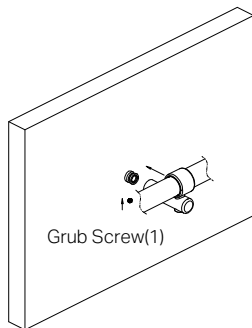

05. Insert the mid bracket into the mounting bracket, then tighten the grub screw(1) to secure it.

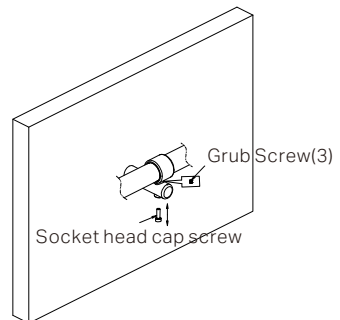

06. Remove the socket head cap screw from the support tube. Tighten grub screw(3) inside the support tube to lock the grab rail in place.

Reinstall and fully tighten the socket head cap screw.

INSTALLATION STEPS FOR 25MM SERIES

FOR 25MM END BRACKET.

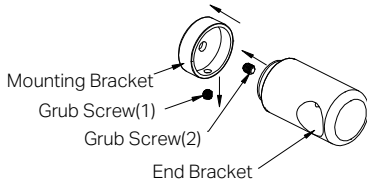

01. Loosen grub screw (1) and remove the mounting bracket. Loosen or remove grub screw (2) from the end bracket.

02. Drill a Ø10mm hole at the desired mounting location.

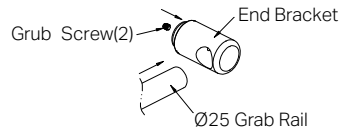
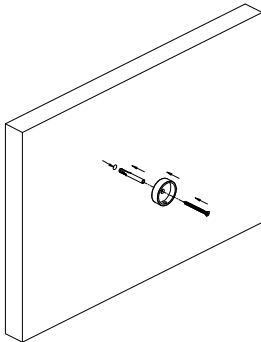

03. Secure the mounting bracket to the wall using the supplied expansion plug and self-tapping screw. Ensure it is firmly fixed.

04. Insert the Ø25mm grab rail fully into the end bracket. Tighten grub screw (2) to secure the rail.

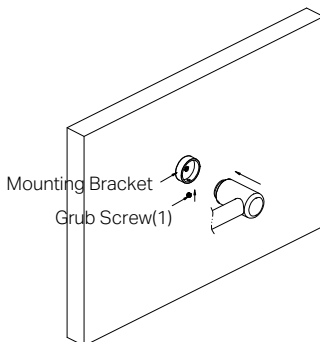

05. Insert the end bracket into the mounting bracket.

Tighten grub screw (1) to complete installation.

INSTALLATION STEPS FOR 25MM SERIES

FOR 25MM DOUBLE TOWEL BRACKET (LEFT AND RIGHT).

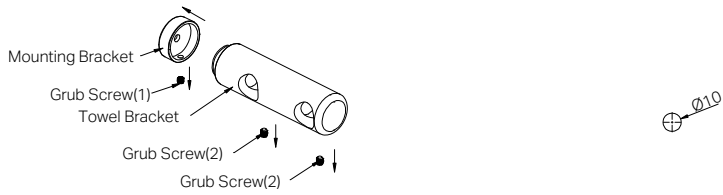

01. Unscrew the grub screw(1) and remove the mounting bracket. Then loosen or remove the grub screws(2) from the towel bracket.

02. Drill a 10mm diameter mounting hole in the wall where the towel bracket is to be installed.

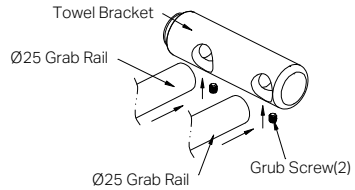
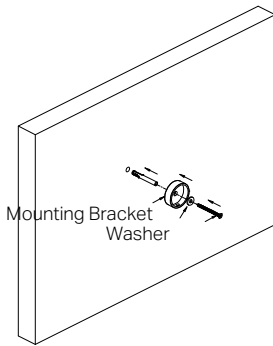

03. Secure the mounting bracket to the wall using the expansion plug, the washer and the self-tapping screw.

04. Insert the grab rails fully into the towel bracket, then tighten the grub screws(2) to secure the grab rails in place.

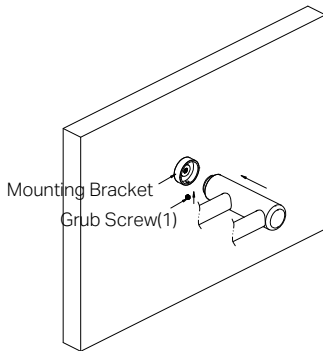

05. Insert the towel bracket into the mounting bracket, then tighten the grub screw(1) to secure it.

INSTALLATION STEPS FOR GRAB RAILS

FOR 25MM AND 32MM GRAB RAILS.

01. Insert the grab rail into the Mecca Care Series Bracket and secure the grab rail with grub screws.

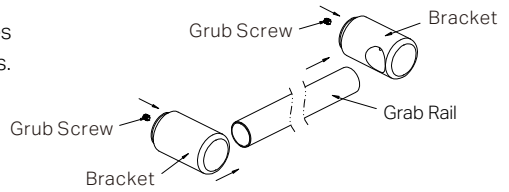

02. Secure the Grab rail and brackets into the mounting brackets on the wall with grub screws.

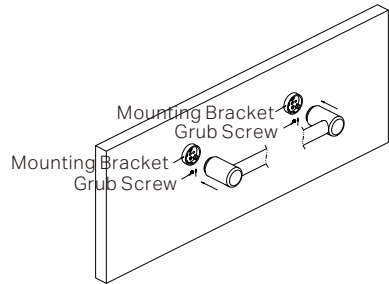

Note:

- This grab rail can be combined with other Mecca Care Grab Rail sets to create various configurations.
- The grab rail can be trimmed or cut according to your required length.
- The grab rail may be installed in either a horizontal or vertical orientation.

FOR 25MM AND 32MM GRAB RAILS SLIDERS.

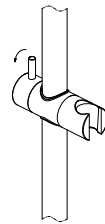
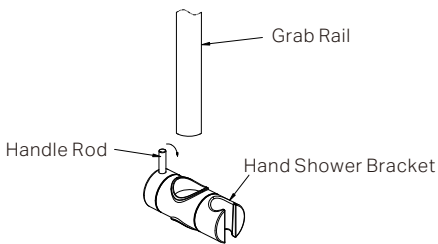

1. Turn the handle rod in the indicated direction to loosen it, and insert the grab rail.

2. Then turn the handle rod in the opposite direction to securely fasten the shower bracket.

Nero

