

Mecca

Hob Bath/Kitchen Mixer Set

Edge Spout II

Nero



Lead Free

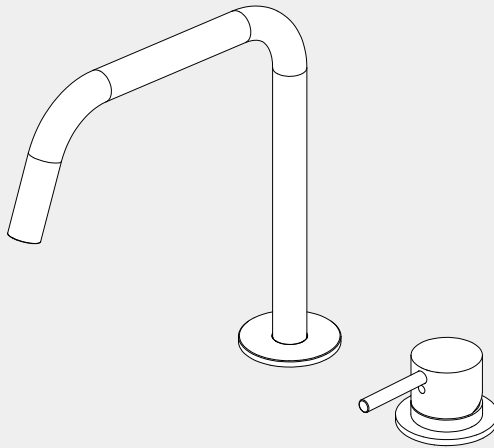

Versions:202511

Drawing

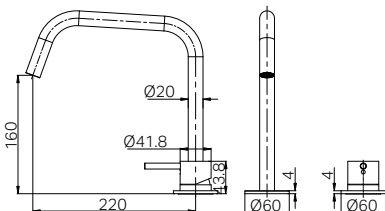

Specifications

Watermark License

WM-060073

Temperature Rating

Min 1 °C - Max 75 °C







Pressure Rating

Min 150 kpa - Max 500 kpa

Packaging Includes

- 1x Spout Set
- 1x Handle Set
- (including 3 flexible hoses)
- 1x Installation Kits

Finish & SKU

- | | | |
|--|--|---|
|  Brushed Bronze
NR221901mBZ |  Matte Black
NR221901mMB |  Chrome
NR221901mCh |
|  Brushed Gold
NR221901mBG |  Brushed Nickel
NR221901mBN |  Gun Metal
NR221901mGM |
|  Matte White
NR221901mMW | | |

*Dimensions are nominal measurements only.

INSTALLATION INSTRUCTIONS

GENERAL INSTRUCTIONS:

- This product must be installed by a licensed plumber. Ensure that the installation complies with the Australian / New Zealand Standard AS/NZS 3500.
- All pipework must be thoroughly flushed prior to the installation of the mixer. In-line filters must be fitted on both hot and cold supplies to prevent foreign particles from damaging the ceramic cartridge.
- All outlets used primarily for personal hygiene must deliver water at a safe temperature in accordance with regional regulations.
- After installation, all connections must be checked for leaks.
- This mixer is not recommended for use in uncontrolled heating systems such as wet-backs or solar heating units unless a suitable tempering valve is fitted.
- If limited water flow is experienced, locate aerator and filter washers and clean away foreign material as required.

MAINTENANCE AND CARE:

- Regularly check the mixer and connections for signs of wear or leaks.
- Clean the tap with mild soapy water to maintain its appearance, avoiding harsh chemicals and abrasive materials that may damage the finish.

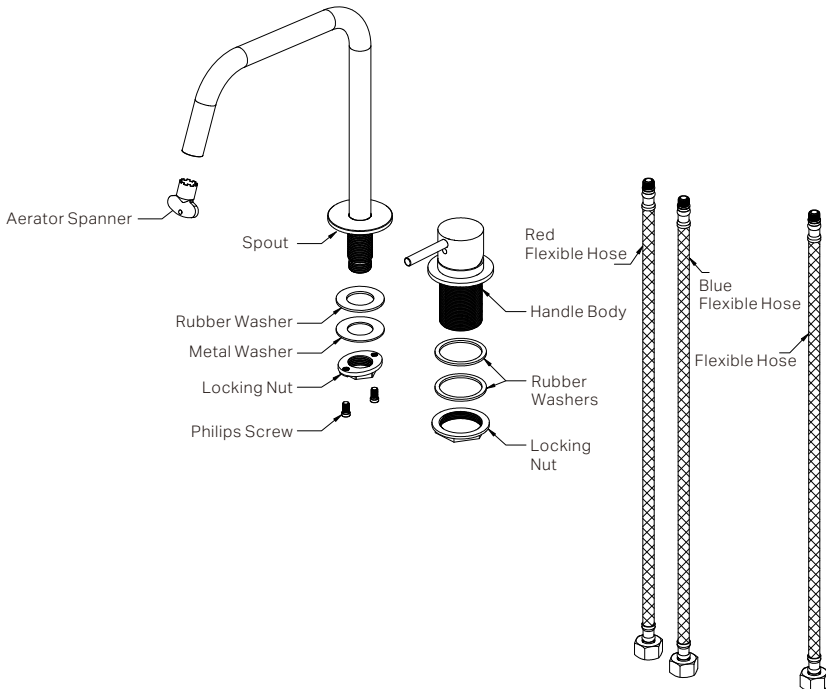

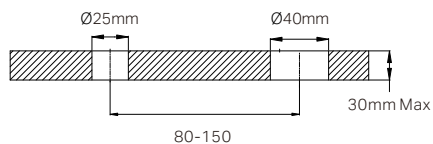

1. Cut holes on the benchtop according to the dimensions shown in the diagram. The distance between the two holes should be 80–150 mm, and the benchtop thickness must not exceed 30 mm.

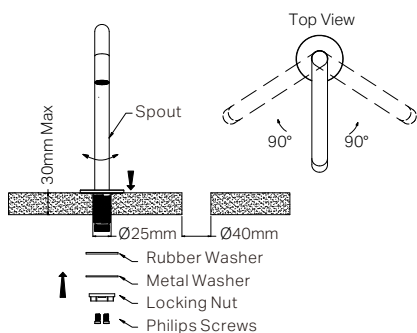

3. Rotate the spout to the midpoint of its 180° swivel range. Insert the spout into the Ø25 mm mounting hole and align it towards the basin. Secure the spout from underneath as shown in the diagram above.

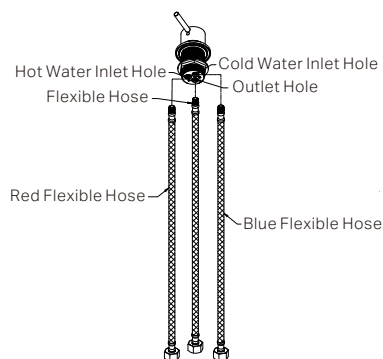

5. Install the three different flexible hoses into the corresponding holes on the handle body as shown in the diagram. Red-H, Blue-C.

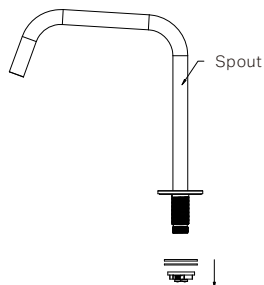

2. Remove the locking nut, metal washer, and rubber washer from the spout.

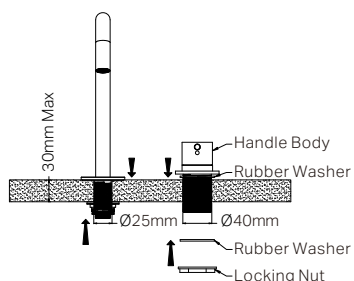

4. Insert the handle body through the Ø40 mm hole (ensure the rubber washer is positioned between the handle and benchtop). Fit the rubber washer and locking nut underneath the benchtop, then tighten securely to hold the handle in place.

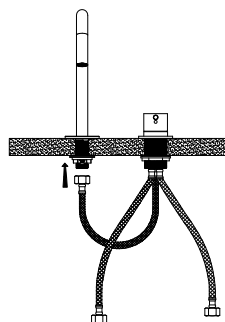

6. Connect the flexible hoses to the spout assembly. The red and blue flexible hoses should be connected to the angle valves.

Nero

